

## MAL209675182E3

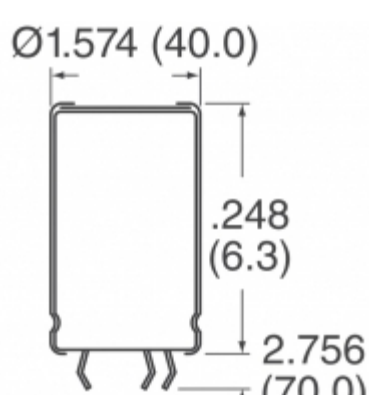

Obrázky jsou pouze orientační.  
Podrobné informace o produktu naleznete v části Technické údaje produktu.  
Koupit MAL209675182E3 s důvěrou od Component-World.HK, 1 rok záruka



**Part Number:** MAL209675182E3  
**Výrobce:** Electro-Films (EFI) / Vishay  
**Popis:** CAP ALUM 1800UF 20% 350V SNAP  
**Datový list:** [096 PLL-4TSI \(MAL2096\) Series](#)  
[Aluminum Electrolytic Capacitors Guide](#)

**RoHS Status:** Bez olova / V souladu RoHS  
**Ship From:** Hong Kong  
**Shipment Way:** DHL/Fedex/TNT/UPS/EMS



[Request For Quotation](#)

### PARAMETR PRODUKTU

<b>Part Number</b>	MAL209675182E3	<b>Výrobce</b>	<a href="#">Electro-Films (EFI) / Vishay</a>
<b>Popis</b>	CAP ALUM 1800UF 20% 350V SNAP	<b>Stav volného vedení / RoHS</b>	Bez olova / V souladu RoHS
<b>Dostupné množství</b>	3425 pcs	<b>Datový list</b>	<a href="#">096 PLL-4TSI (MAL2096) Series</a> <a href="#">Aluminum Electrolytic Capacitors Guide</a>
<b>Kategorie</b>	<a href="#">Kondenzátory</a>	<b>Napětí - Jmenovitá</b>	350V
<b>Tolerance</b>	±20%	<b>Povrchová montáž Land Velikost</b>	-
<b>Velikost / Rozměry</b>	1.575" Dia (40.00mm)	<b>Série</b>	096 PLL-4TSI
<b>Ripple Current @ Low Frequency</b>	6.9A @ 100Hz	<b>hodnocení</b>	-
<b>Polarizace</b>	Polar	<b>Obal</b>	Tape & Box (TB)
<b>Paket / krabice</b>	Radial, Can - 5 Lead	<b>Provozní teplota</b>	-40°C ~ 85°C
<b>Typ montáže</b>	Through Hole	<b>Úroveň citlivosti na vlhkost (MSL)</b>	1 (Unlimited)
<b>Výrobní standardní doba výroby</b>	21 Weeks	<b>Životnost @ Temp.</b>	5000 Hrs @ 85°C
<b>Rozestup vývodů</b>	0.787" (20.00mm)	<b>Stav volného vedení / RoHS</b>	Lead free / RoHS Compliant
<b>Impedance</b>	41 mOhms	<b>Výška - Sedící (Max)</b>	3.346" (85.00mm)
<b>ESR (Equivalent Resistance Series)</b>	143 mOhm @ 100Hz	<b>Detailní popis</b>	1800µF 350V Aluminum Electrolytic Capacitors Radial, Can - 5 Lead 143 mOhm @ 100Hz 5000 Hrs @ 85°C
<b>kapacitní</b>	1800µF	<b>Aplikace</b>	General Purpose

Component-World.com je spolehlivý distributor elektronických součástek. Specializujeme se na všechny elektronické komponenty řady Electro-Films (EFI) / Vishay. Máme 3425 kusy Electro-Films (EFI) / Vishay MAL209675182E3 na skladě dostupných. Vyžádejte si citát z distributora součástí elektroniky na Component-World.com, náš prodejní tým vás bude kontaktovat do 24 hodin.  
RFQ Email: [info@Components-World.com](mailto:info@Components-World.com)

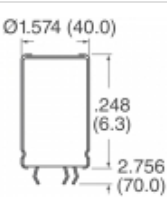
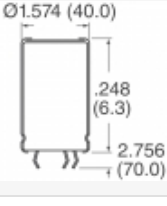
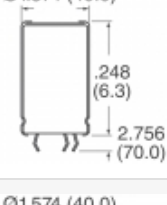
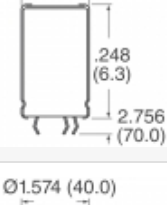
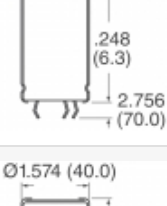
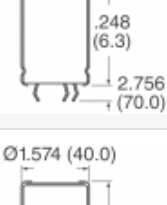
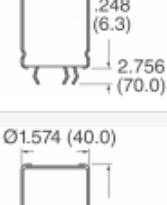
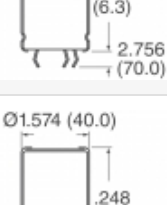
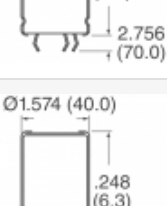
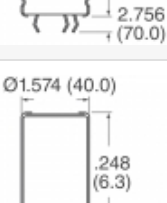
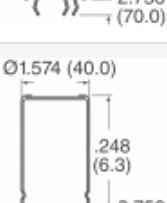
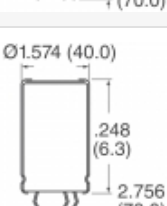
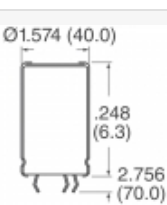
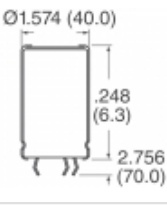
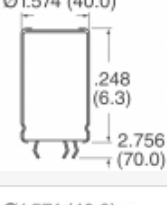
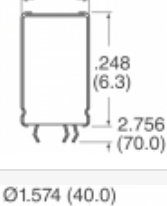
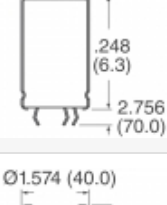
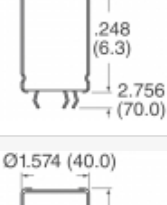
### SOUVISEJÍCÍ PRODUKTY

	<b>Část#:</b> <a href="#">MAL209676821E3</a> <b>Popis:</b> CAP ALUM 820UF 20% 400V SNAP	<b>Výrobci:</b> <a href="#">Electro-Films (EFI) / Vishay</a>	<a href="#">Dotaz</a>
	<b>Část#:</b> <a href="#">MAL209676182E3</a> <b>Popis:</b> CAP ALUM 1800UF 20% 400V SNAP	<b>Výrobci:</b> <a href="#">Electro-Films (EFI) / Vishay</a>	<a href="#">Dotaz</a>
	<b>Část#:</b> <a href="#">MAL209674182E3</a> <b>Popis:</b> CAP ALUM 1800UF 20% 420V SNAP	<b>Výrobci:</b> <a href="#">Electro-Films (EFI) / Vishay</a>	<a href="#">Dotaz</a>
	<b>Část#:</b> <a href="#">MAL209675152E3</a> <b>Popis:</b> CAP ALUM 1500UF 20% 350V SNAP	<b>Výrobci:</b> <a href="#">Electro-Films (EFI) / Vishay</a>	<a href="#">Dotaz</a>
	<b>Část#:</b> <a href="#">MAL209676102E3</a> <b>Popis:</b> CAP ALUM 1000UF 20% 400V SNAP	<b>Výrobci:</b> <a href="#">Electro-Films (EFI) / Vishay</a>	<a href="#">Dotaz</a>
	<b>Část#:</b> <a href="#">MAL209676152E3</a> <b>Popis:</b> CAP ALUM 1500UF 20% 400V SNAP	<b>Výrobci:</b> <a href="#">Electro-Films (EFI) / Vishay</a>	<a href="#">Dotaz</a>
	<b>Část#:</b> <a href="#">MAL209675222E3</a> <b>Popis:</b> CAP ALUM 2200UF 20% 350V SNAP	<b>Výrobci:</b> <a href="#">Electro-Films (EFI) / Vishay</a>	<a href="#">Dotaz</a>
	<b>Část#:</b> <a href="#">MAL209674152E3</a> <b>Popis:</b> CAP ALUM 1500UF 20% 420V SNAP	<b>Výrobci:</b> <a href="#">Electro-Films (EFI) / Vishay</a>	<a href="#">Dotaz</a>
	<b>Část#:</b> <a href="#">MAL209675122E3</a> <b>Popis:</b> CAP ALUM 1200UF 20% 350V SNAP	<b>Výrobci:</b> <a href="#">Electro-Films (EFI) / Vishay</a>	<a href="#">Dotaz</a>
	<b>Část#:</b> <a href="#">MAL209669821E3</a> <b>Popis:</b> CAP ALUM 820UF 20% 500V SNAP	<b>Výrobci:</b> <a href="#">Electro-Films (EFI) / Vishay</a>	<a href="#">Dotaz</a>
	<b>Část#:</b> <a href="#">MAL209676681E3</a> <b>Popis:</b> CAP ALUM 680UF 20% 400V SNAP	<b>Výrobci:</b> <a href="#">Electro-Films (EFI) / Vishay</a>	<a href="#">Dotaz</a>
	<b>Část#:</b> <a href="#">MAL209674102E3</a> <b>Popis:</b> CAP ALUM 1000UF 20% 420V SNAP	<b>Výrobci:</b> <a href="#">Electro-Films (EFI) / Vishay</a>	<a href="#">Dotaz</a>
	<b>Část#:</b> <a href="#">MAL209677102E3</a> <b>Popis:</b> CAP ALUM 1000UF 20% 450V SNAP	<b>Výrobci:</b> <a href="#">Electro-Films (EFI) / Vishay</a>	<a href="#">Dotaz</a>
	<b>Část#:</b> <a href="#">MAL209676122E3</a> <b>Popis:</b> CAP ALUM 1200UF 20% 400V SNAP	<b>Výrobci:</b> <a href="#">Electro-Films (EFI) / Vishay</a>	<a href="#">Dotaz</a>
	<b>Část#:</b> <a href="#">MAL209677122E3</a> <b>Popis:</b> CAP ALUM 1200UF 20% 450V SNAP	<b>Výrobci:</b> <a href="#">Electro-Films (EFI) / Vishay</a>	<a href="#">Dotaz</a>
	<b>Část#:</b> <a href="#">MAL209675102E3</a> <b>Popis:</b> CAP ALUM 1000UF 20% 350V SNAP	<b>Výrobci:</b> <a href="#">Electro-Films (EFI) / Vishay</a>	<a href="#">Dotaz</a>
	<b>Část#:</b> <a href="#">MAL209674122E3</a> <b>Popis:</b> CAP ALUM 1200UF 20% 420V SNAP	<b>Výrobci:</b> <a href="#">Electro-Films (EFI) / Vishay</a>	<a href="#">Dotaz</a>
	<b>Část#:</b> <a href="#">MAL209674681E3</a> <b>Popis:</b> CAP ALUM 680UF 20% 420V SNAP	<b>Výrobci:</b> <a href="#">Electro-Films (EFI) / Vishay</a>	<a href="#">Dotaz</a>
	<b>Část#:</b> <a href="#">MAL209674821E3</a> <b>Popis:</b> CAP ALUM 820UF 20% 420V SNAP	<b>Výrobci:</b> <a href="#">Electro-Films (EFI) / Vishay</a>	<a href="#">Dotaz</a>
	<b>Část#:</b> <a href="#">MAL209675821E3</a> <b>Popis:</b> CAP ALUM 820UF 20% 350V SNAP	<b>Výrobci:</b> <a href="#">Electro-Films (EFI) / Vishay</a>	<a href="#">Dotaz</a>

### Související klíčová slova pro MAL209675182E3

Electro-Films (EFI) / Vishay MAL209675182E3.	MAL209675182E3 distributor	MAL209675182E3 dodavatel	MAL209675182E3 Cena
MAL209675182E3 Stáhnout datasheet.	MAL209675182E3 Datasheet.	MAL209675182E3 Stock.	koupit MAL209675182E3.
Electro-Films (EFI) / Vishay MAL209675182E3.	Electro-Films (EFI) / Vishay MAL209675182E3.	Vishay Electro-Films MAL209675182E3.	Phoenix Passive Components / Vishay MAL209675182E3.